

FRONTLINE
COMMUNICATIONS
A Division of Pierce Manufacturing Inc.

Chesterfield County VA
Mobile Command Unit
C-40 X-4 - Velocity

THIS DRAWING IS THE PROPERTY OF PIERCE MANUFACTURING. IT IS CONFIDENTIAL AND ALL RIGHTS ARE RESERVED. IT SHALL NOT BE REPRODUCED, COPIED, LENT, OR USED FOR ANY PURPOSE OTHER THAN THAT FOR WHICH IT IS SPECIFICALLY FURNISHED.

BID # 799
REP: Kevin Sandridge - Atlantic Emergency Solutions
DEALER: Steve Williamson - Frontline Communications

PRELIMINARY USE ONLY
THIS DRAWING IS FOR REPRESENTATION ONLY. DETAILED ENGINEERING DRAWINGS WILL BE CREATED FOR MANUFACTURING. CHANGES MAY BE REQUIRED TO ACCOMMODATE MANUFACTURING REQUIREMENTS AND CUSTOMER SPECIFICATIONS.

DRAWN	MRS	DATE	1/3/22
SHEET	1 OF 6	NOT TO SCALE	

SIZE	DWG NO.	REV
B	P2022-31	A

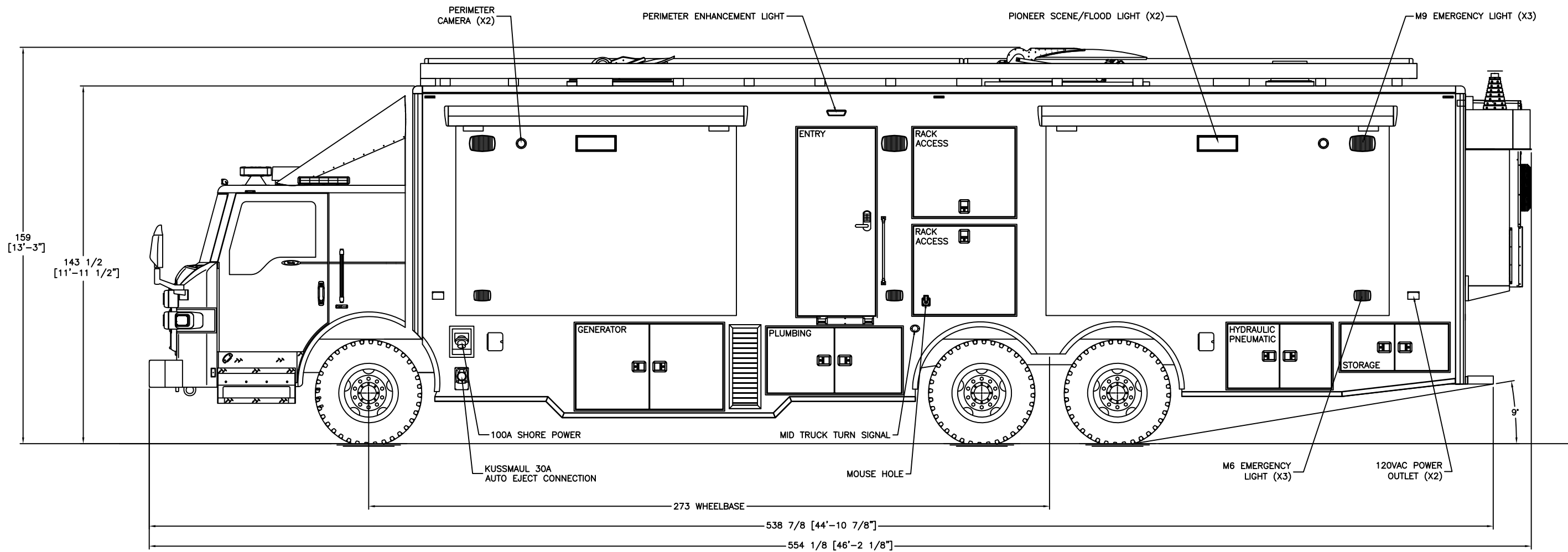

FRONTLINE
COMMUNICATIONS

A Division of Pierce Manufacturing Inc.

Chesterfield County VA
Mobile Command Unit
C-40 X-4 - Velocity

PRELIMINARY USE ONLY

THIS DRAWING IS FOR REPRESENTATION ONLY. DETAILED ENGINEERING DRAWINGS WILL BE CREATED FOR MANUFACTURING. CHANGES MAY BE REQUIRED TO ACCOMMODATE MANUFACTURING REQUIREMENTS AND CUSTOMER SPECIFICATIONS.

DRAWN	MRS	DATE	1/3/22
SHEET	2 OF 6	NOT TO SCALE	

SIZE	DWG NO.	REV
B	P2022-31	A

THIS DRAWING IS THE PROPERTY OF PIERCE MANUFACTURING. IT IS CONFIDENTIAL AND ALL RIGHTS ARE RESERVED. IT SHALL NOT BE REPRODUCED, COPIED, LENT, OR USED FOR ANY PURPOSE OTHER THAN THAT FOR WHICH IT IS SPECIFICALLY FURNISHED.

BID # 799
 REP: Kevin Sandridge - Atlantic Emergency Solutions
 DEALER: Steve Williamson - Frontline Communications

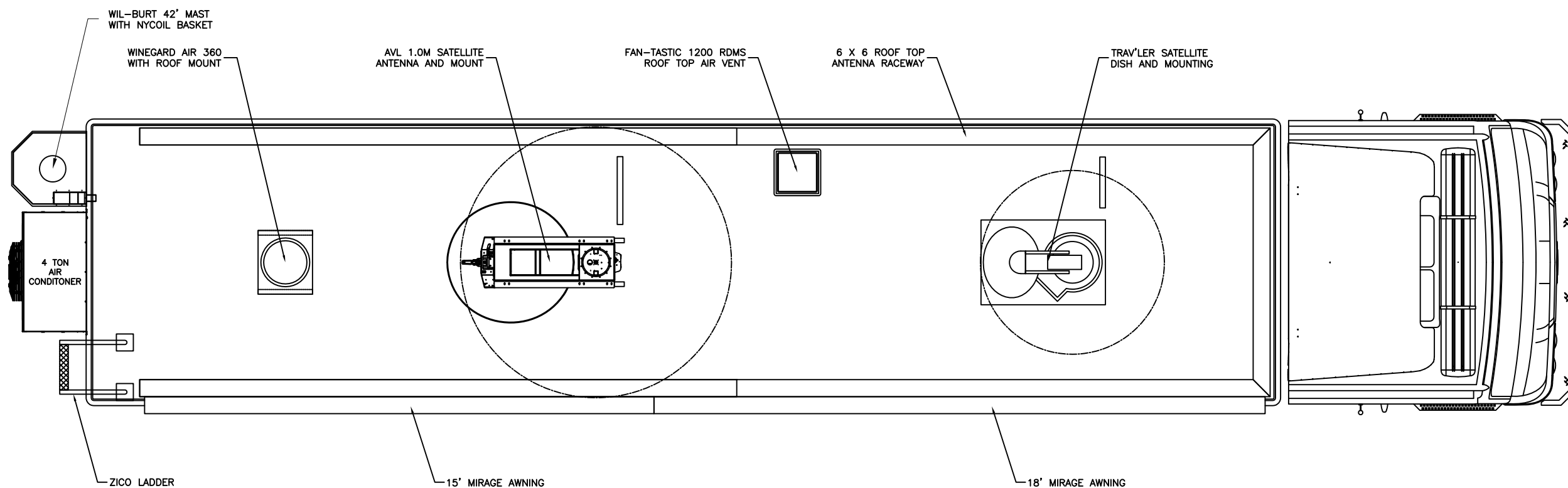

FRONTLINE
COMMUNICATIONS
A Division of Pierce Manufacturing Inc.

Chesterfield County VA
Mobile Command Unit
C-40 X-4 - Velocity

THIS DRAWING IS THE PROPERTY OF PIERCE MANUFACTURING. IT IS CONFIDENTIAL AND ALL RIGHTS ARE RESERVED. IT SHALL NOT BE REPRODUCED, COPIED, LENT, OR USED FOR ANY PURPOSE OTHER THAN THAT FOR WHICH IT IS SPECIFICALLY FURNISHED.

BID # 799
REP: Kevin Sandridge - Atlantic Emergency Solutions
DEALER: Steve Williamson - Frontline Communications

PRELIMINARY USE ONLY
THIS DRAWING IS FOR REPRESENTATION ONLY. DETAILED ENGINEERING DRAWINGS WILL BE CREATED FOR MANUFACTURING. CHANGES MAY BE REQUIRED TO ACCOMMODATE MANUFACTURING REQUIREMENTS AND CUSTOMER SPECIFICATIONS.

DRAWN	MRS	DATE	1/3/22
SHEET	3 OF 6	NOT TO SCALE	

SIZE	DWG NO.	REV
B	P2022-31	A

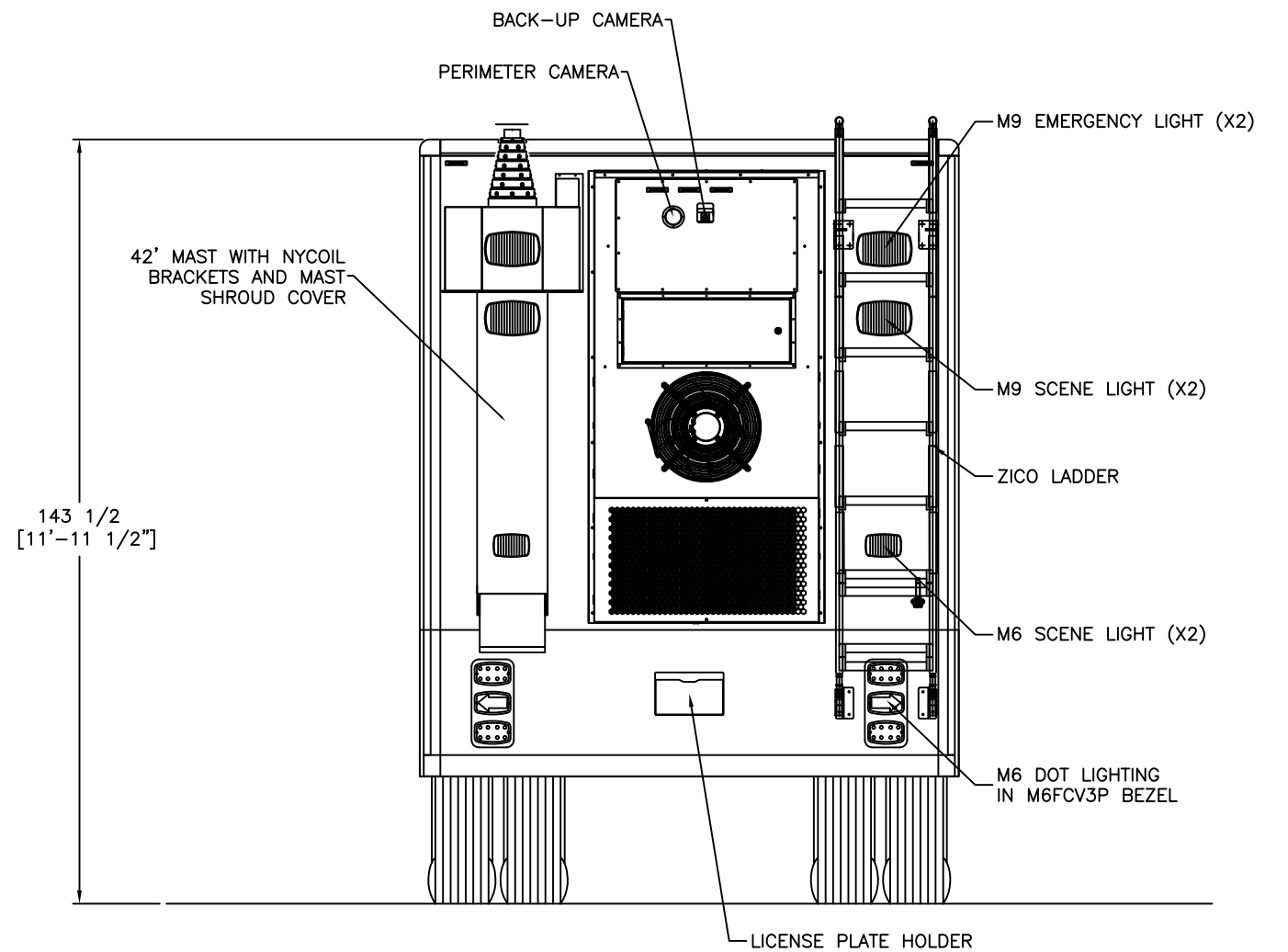
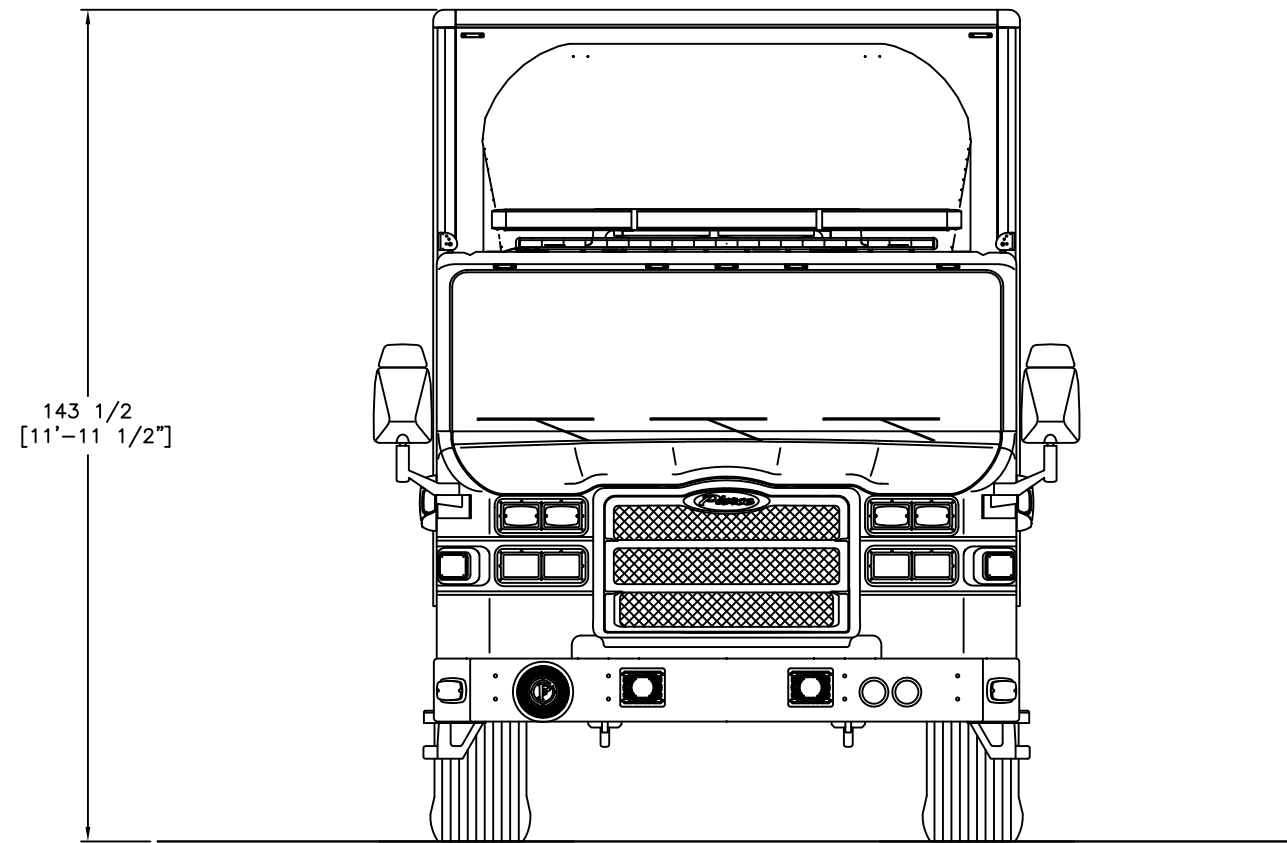

THIS DRAWING IS THE PROPERTY OF PIERCE MANUFACTURING. IT IS CONFIDENTIAL AND ALL RIGHTS ARE RESERVED. IT SHALL NOT BE REPRODUCED, COPIED, LENT, OR USED FOR ANY PURPOSE OTHER THAN THAT FOR WHICH IT IS SPECIFICALLY FURNISHED.

BID # 799
REP: Kevin Sandridge - Atlantic Emergency Solutions
DEALER: Steve Williamson - Frontline Communications

PRELIMINARY USE ONLY
 THIS DRAWING IS FOR REPRESENTATION ONLY. DETAILED ENGINEERING DRAWINGS WILL BE CREATED FOR MANUFACTURING. CHANGES MAY BE REQUIRED TO ACCOMMODATE MANUFACTURING REQUIREMENTS AND CUSTOMER SPECIFICATIONS.

FRONTLINE
COMMUNICATIONS
 A Division of Pierce Manufacturing Inc.

DRAWN **MRS** DATE **1/3/22**
 SHEET **4 OF 6** NOT TO SCALE

Chesterfield County VA
Mobile Command Unit
C-40 X-4 - Velocity

SIZE **B** DWG NO. **P2022-31** REV **A**

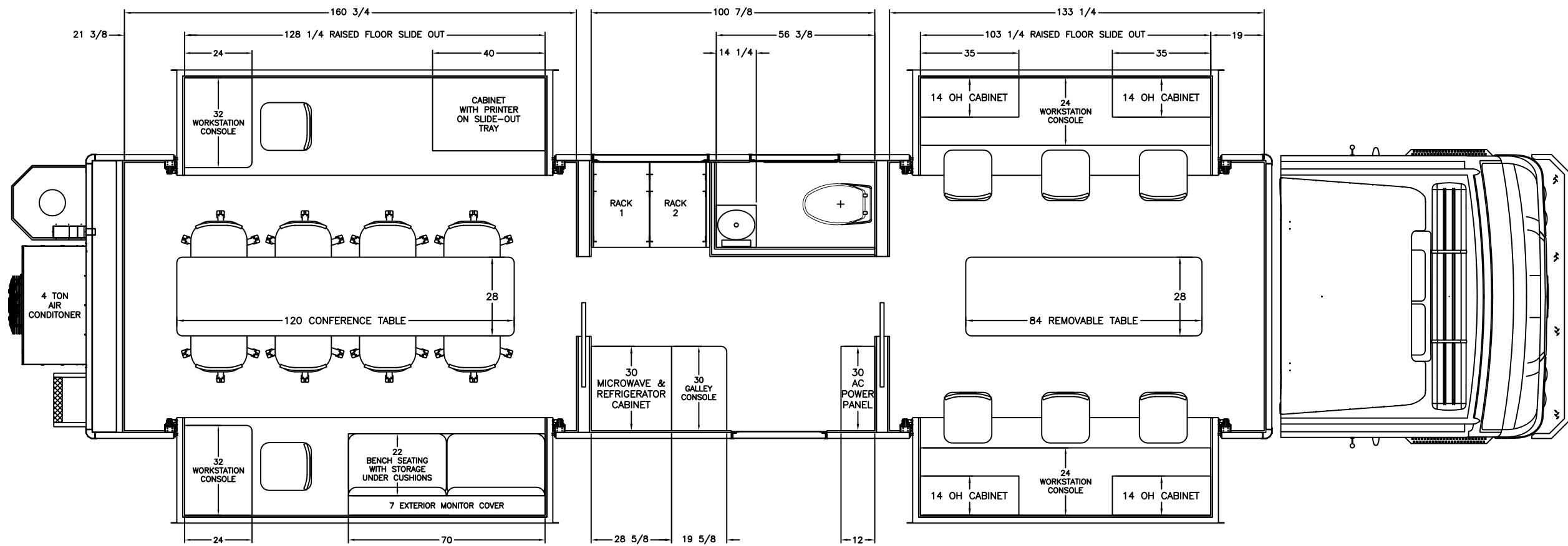

FRONTLINE
COMMUNICATIONS
A Division of Pierce Manufacturing Inc.

Chesterfield County VA
Mobile Command Unit
C-40 X-4 - Velocity

THIS DRAWING IS THE PROPERTY OF PIERCE MANUFACTURING. IT IS CONFIDENTIAL AND ALL RIGHTS ARE RESERVED. IT SHALL NOT BE REPRODUCED, COPIED, LENT, OR USED FOR ANY PURPOSE OTHER THAN THAT FOR WHICH IT IS SPECIFICALLY FURNISHED.

BID # 799
 REP: Kevin Sandridge - Atlantic Emergency Solutions
 DEALER: Steve Williamson - Frontline Communications

PRELIMINARY USE ONLY
 THIS DRAWING IS FOR REPRESENTATION ONLY. DETAILED ENGINEERING DRAWINGS WILL BE CREATED FOR MANUFACTURING. CHANGES MAY BE REQUIRED TO ACCOMMODATE MANUFACTURING REQUIREMENTS AND CUSTOMER SPECIFICATIONS.

DRAWN	MRS	DATE	1/3/22
SHEET	5 OF 6	NOT TO SCALE	

SIZE	DWG NO.	REV
B	P2022-31	A

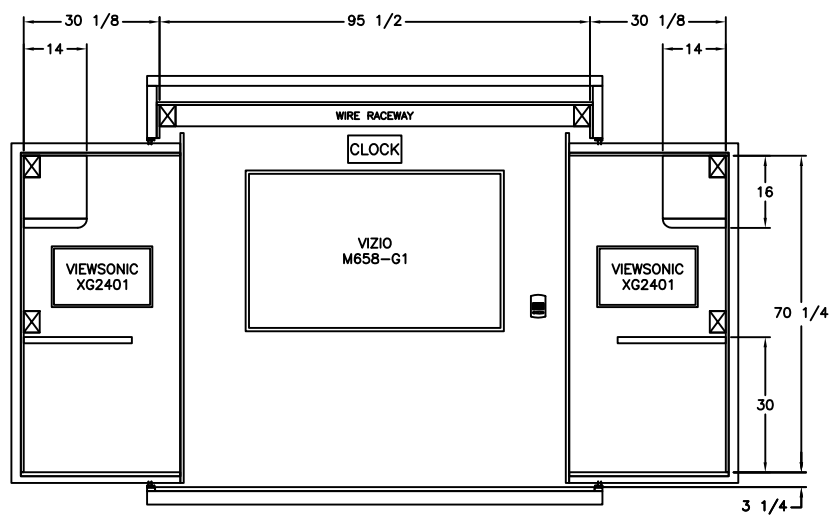

FRONT WALL INTERIOR LAYOUT

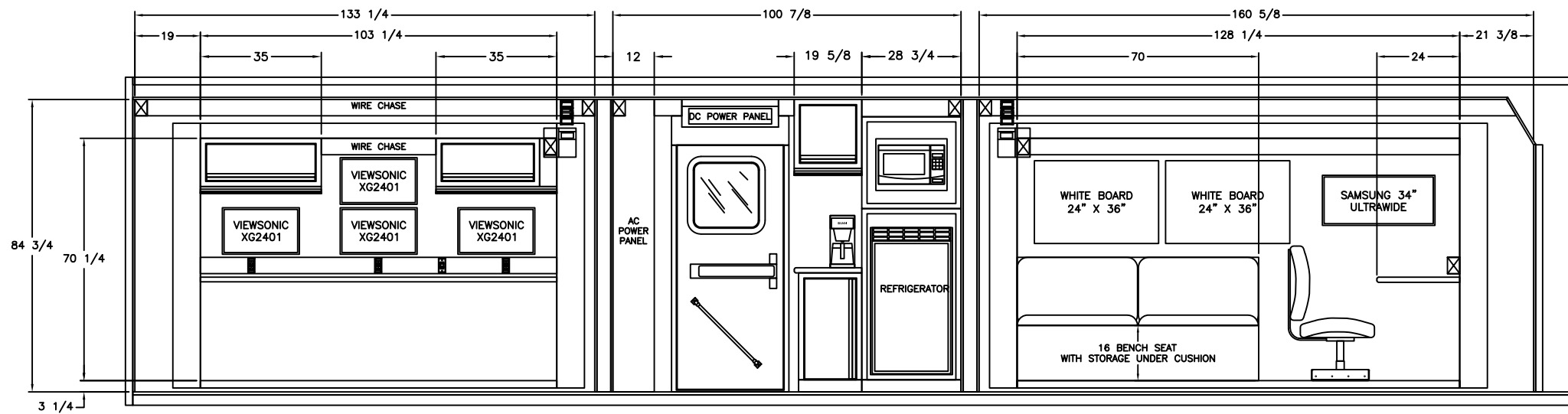

PASSENGERS SIDE INTERIOR LAYOUT

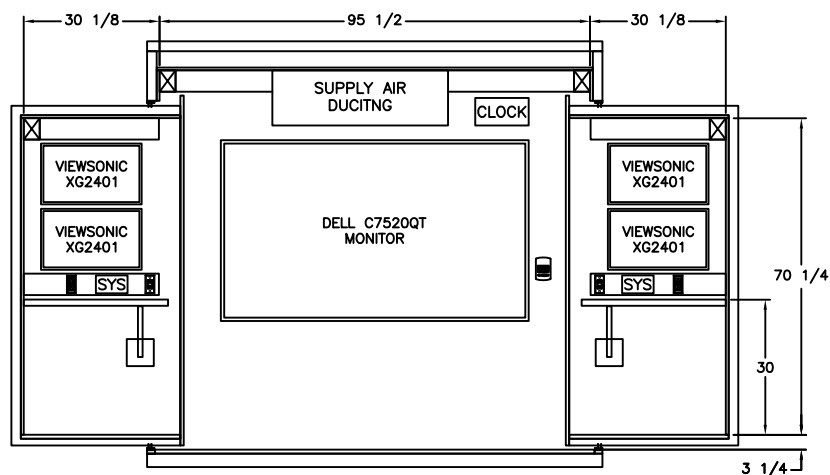

REAR WALL INTERIOR LAYOUT

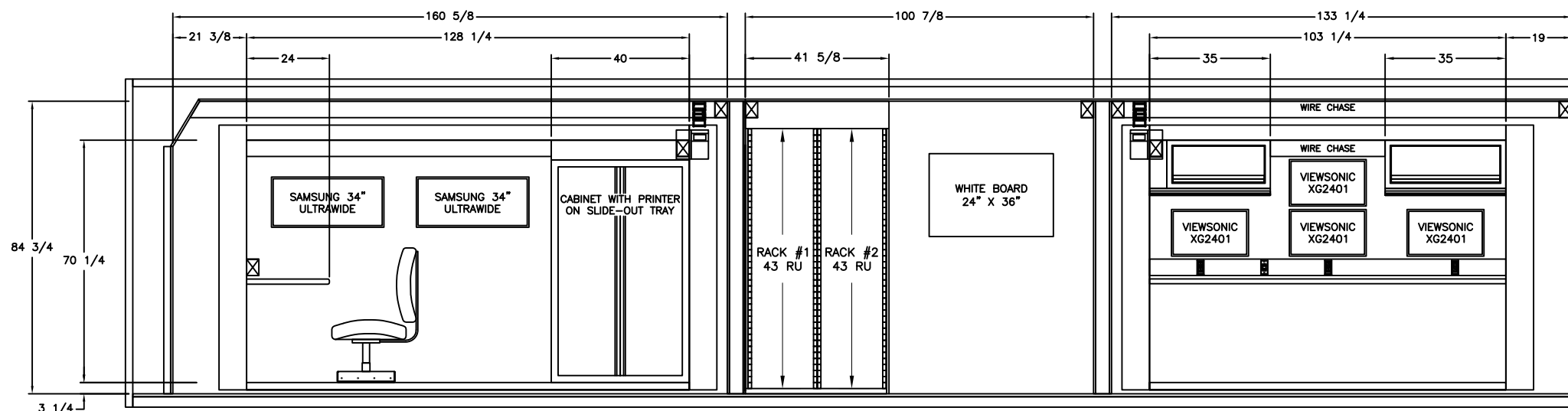

DRIVERS SIDE INTERIOR LAYOUT

FRONTLINE
COMMUNICATIONS

A Division of Pierce Manufacturing Inc.

Chesterfield County VA
Mobile Command Unit
C-40 X-4 - Velocity

PRELIMINARY USE ONLY

THIS DRAWING IS FOR REPRESENTATION ONLY. DETAILED ENGINEERING DRAWINGS WILL BE CREATED FOR MANUFACTURING. CHANGES MAY BE REQUIRED TO ACCOMMODATE MANUFACTURING REQUIREMENTS AND CUSTOMER SPECIFICATIONS.

DRAWN	MRS	DATE	1/3/22
SHEET	6 OF 6	NOT TO SCALE	

SIZE	B	DWG NO.	P2022-31	REV	A
------	---	---------	----------	-----	---

BID # 799
REP: Kevin Sandridge - Atlantic Emergency Solutions
DEALER: Steve Williamson - Frontline Communications

THIS DRAWING IS THE PROPERTY OF PIERCE MANUFACTURING. IT IS CONFIDENTIAL AND ALL RIGHTS ARE RESERVED. IT SHALL NOT BE REPRODUCED, COPIED, LENT, OR USED FOR ANY PURPOSE OTHER THAN THAT FOR WHICH IT IS SPECIFICALLY FURNISHED.