

| REVISIONS |      |        |             |          |     |     |
|-----------|------|--------|-------------|----------|-----|-----|
| CHK       | DATE | CHK BY | DESCRIPTION | DATE     | BY  | REV |
| 04/26/23  |      | MD     | CDR UPDATES | 04/12/23 | JRP | 01  |

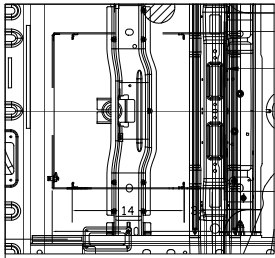

RACK TOP VIEW  
3.5" SET BACK FOR FRONT  
WIRING BEHIND DOOR UNDER  
CONSOLE

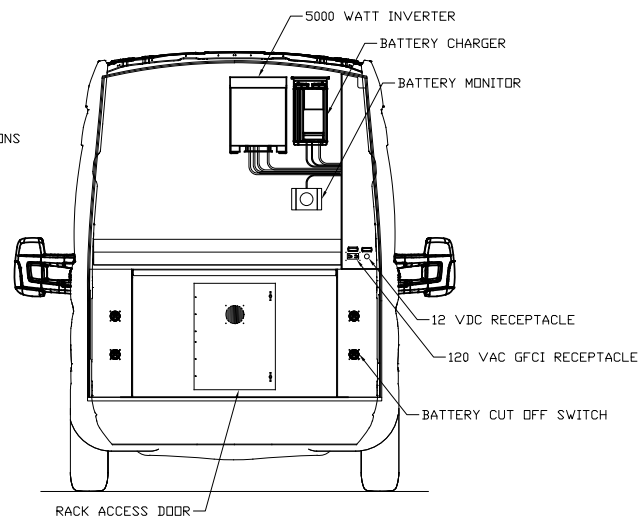
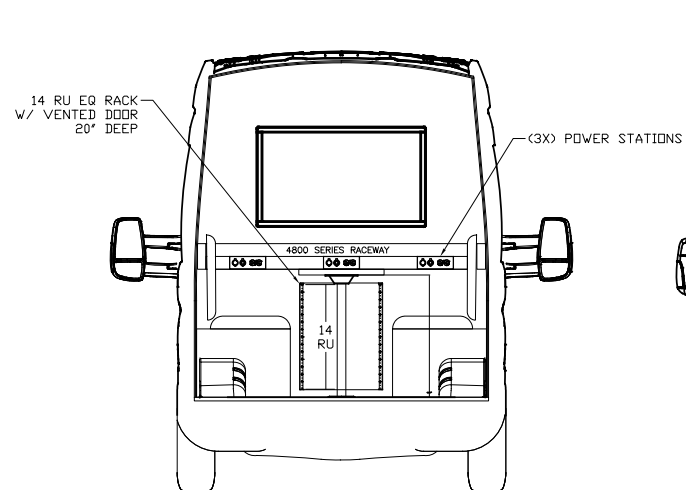
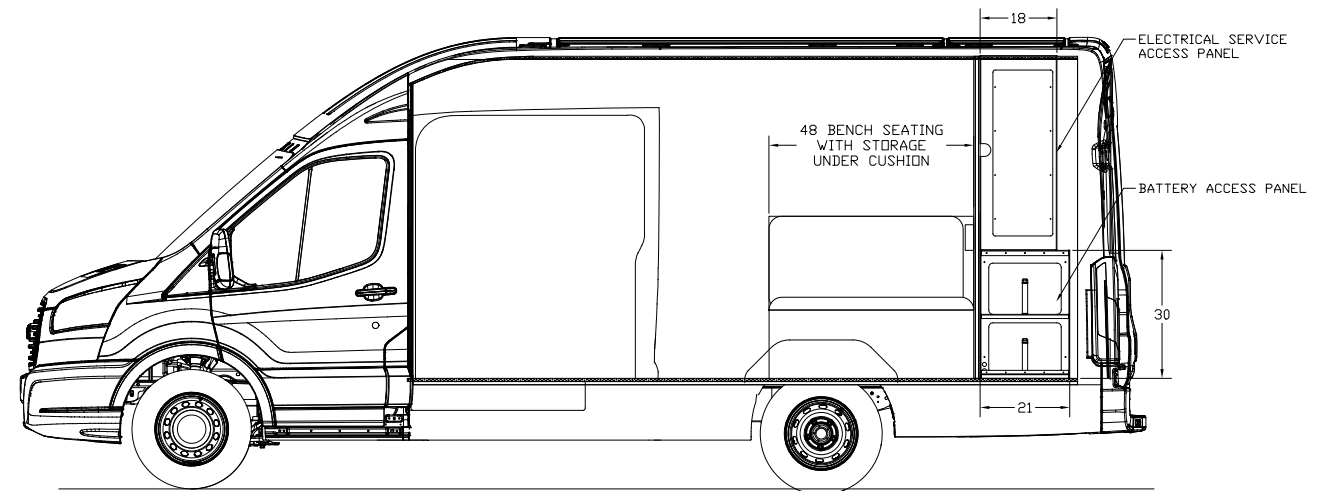
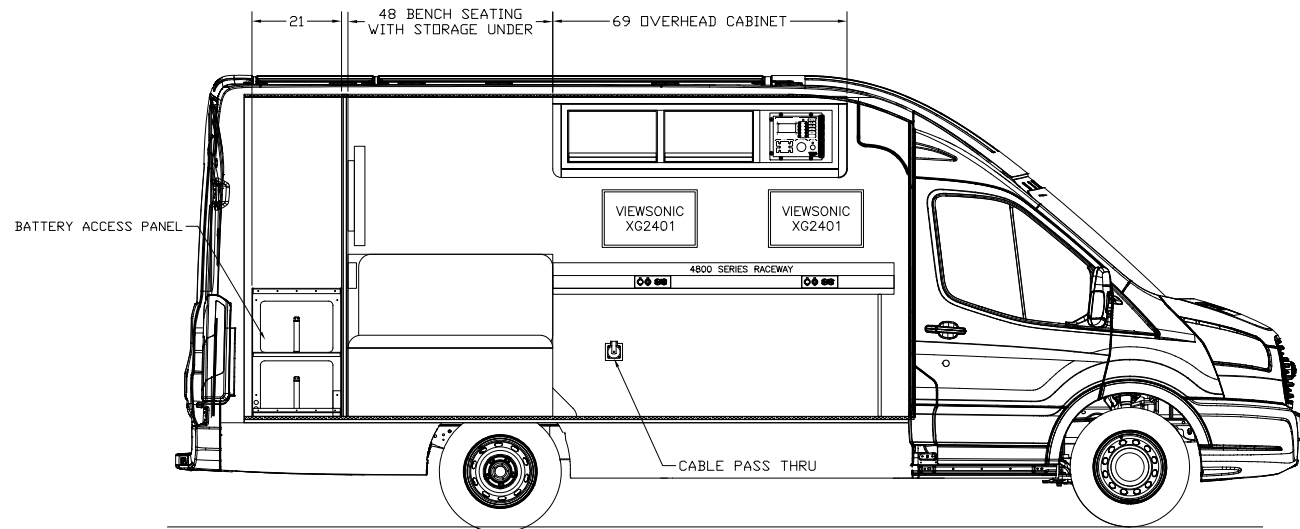
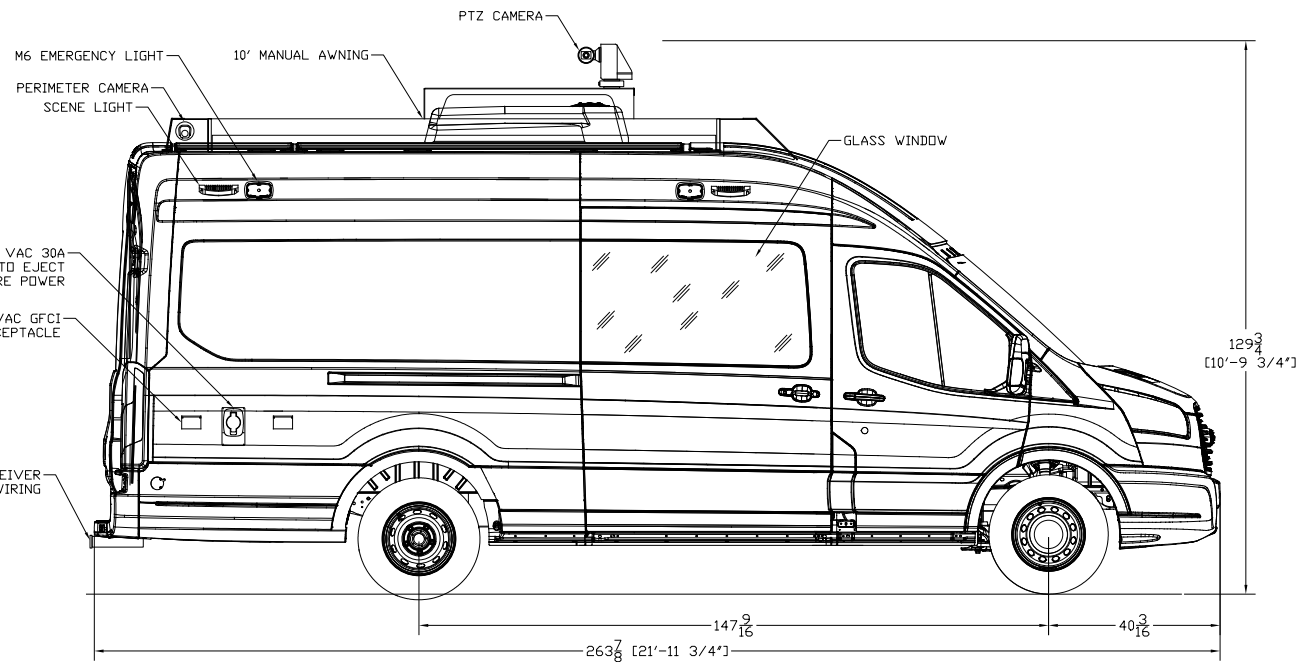
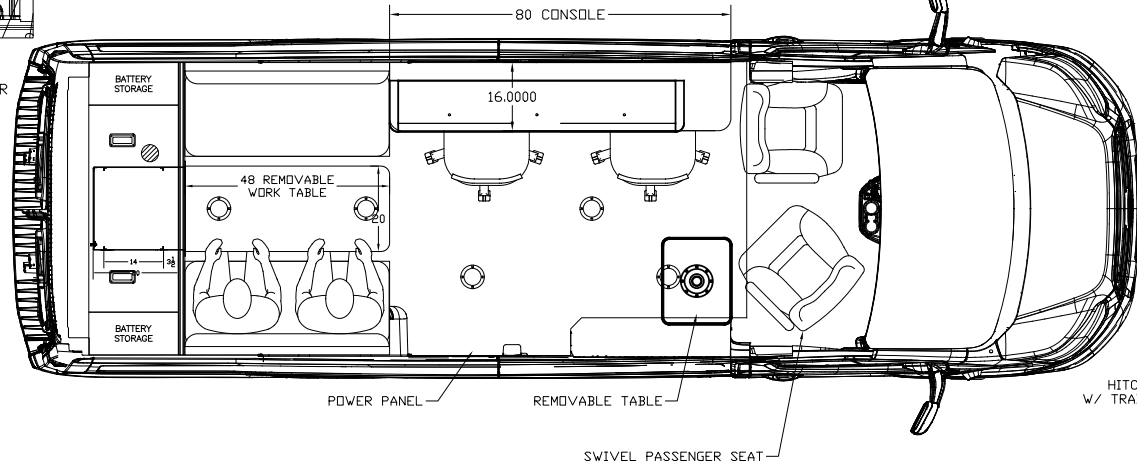

**PRELIMINARY USE ONLY**  
THIS DRAWING IS FOR REPRESENTATION ONLY. DETAILED ENGINEERING DRAWINGS WILL BE CREATED FOR MANUFACTURING. CHANGES MAY BE REQUIRED TO ACCOMMODATE MANUFACTURING REQUIREMENTS AND CUSTOMER SPECIFICATIONS.

THIS DRAWING IS THE PROPERTY OF FRONTLINE COMMUNICATIONS CORPORATION. IT IS CONFIDENTIAL AND ALL RIGHTS ARE RESERVED. IT SHALL NOT BE REPRODUCED, COPIED, LENT, NOR USED FOR ANY PURPOSE OTHER THAN THAT FOR WHICH IT IS SPECIFICALLY FURNISHED.

DO NOT SCALE THIS DRAWING  
DIMENSIONS ARE IN INCHES  
UNLESS OTHERWISE SPECIFIED

TOLERANCES:  
ANGULAR: ± 1° BEND: ± 1"  
2 PLACE DECIMAL ± .010  
3 PLACE DECIMAL ± .005  
FRACTIONS ± 1/16

JOB NUMBER OR PRODUCT LINE  
**72003**

SHEET 1 OF 1 SCALE 1:38

|            |          |
|------------|----------|
| MATERIAL   | N/A      |
| FINISH     | N/A      |
| DRAWN BY   | JRP      |
| DATE       | 04/26/23 |
| CHECKED BY | MD       |
| DATE       | 04/26/23 |

**FRONTLINE COMMUNICATIONS**  
An Oshkosh Corporation Company

12770 44th Street North  
Clearwater, FL 33762-4713  
(727) 573-0400  
FAX (727) 571-3295

**FIU MCU  
ELEVATION DRAWING  
Transit EL HR**

SIZE **B** DWG NO. **053195**