

REVISIONS

CHK DATE	CHK BY	DESCRIPTION	DATE	BY	REV
1/12/22	CJM	CHASSIS CHANGED PER CUSTOMER - CO#1	4/7/21	MRS	02

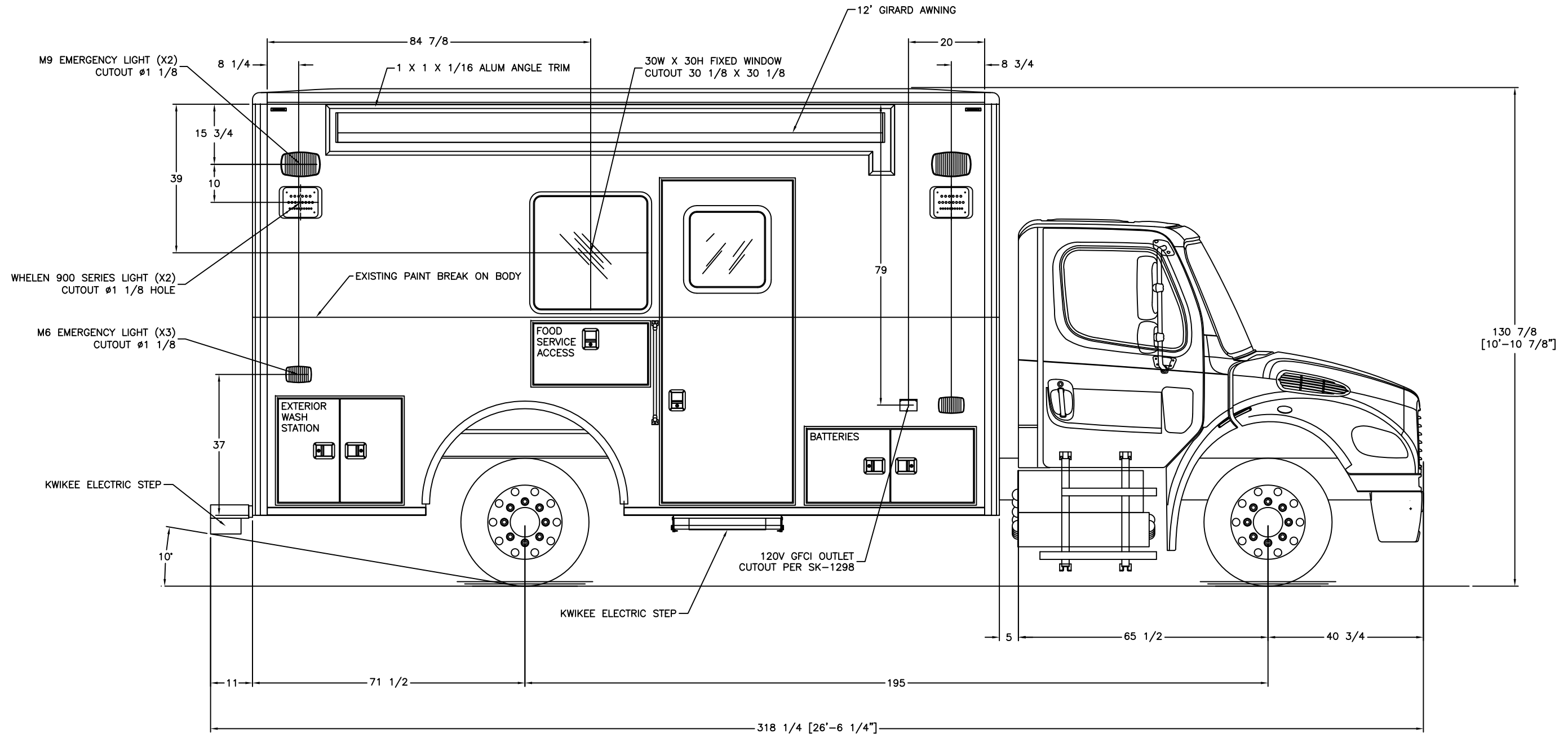

THIS DRAWING IS THE PROPERTY OF PIERCE MANUFACTURING CORPORATION. IT IS CONFIDENTIAL AND ALL RIGHTS ARE RESERVED. IT SHALL NOT BE REPRODUCED, COPIED, LENT, NOR USED FOR ANY PURPOSE OTHER THAN THAT FOR WHICH IT IS SPECIFICALLY FURNISHED.

DO NOT SCALE THIS DRAWING DIMENSIONS ARE IN INCHES UNLESS OTHERWISE SPECIFIED	
TOLERANCES: ANGULAR: \pm 1° BEND: \pm 1" 2 PLACE DECIMAL \pm .010 3 PLACE DECIMAL \pm .005 FRACTIONS \pm 1/16	
JOB NUMBER OR PRODUCT LINE 91937	SHEET 1 OF 1
SCALE 30	

MATERIAL SEE NOTES	
FINISH MILL FINISH	
DRAWN BY MRS	DATE 9/16/20
CHECKED BY JAB	DATE 09/17/20

Pierce 12770 44th Street North
Clearwater, FL 33762-4713
(727) 573-0400
FAX (727) 571-3295

EXTERIOR LAYOUT CURB SIDE

SIZE B	DWG NO. 91937-50200
------------------	-------------------------------

REVISIONS					
CHK DATE	CHK BY	DESCRIPTION	DATE	BY	REV
1/12/22	CJM	CHASSIS CHANGED PER CUSTOMER - CO#1	4/7/21	MRS	02

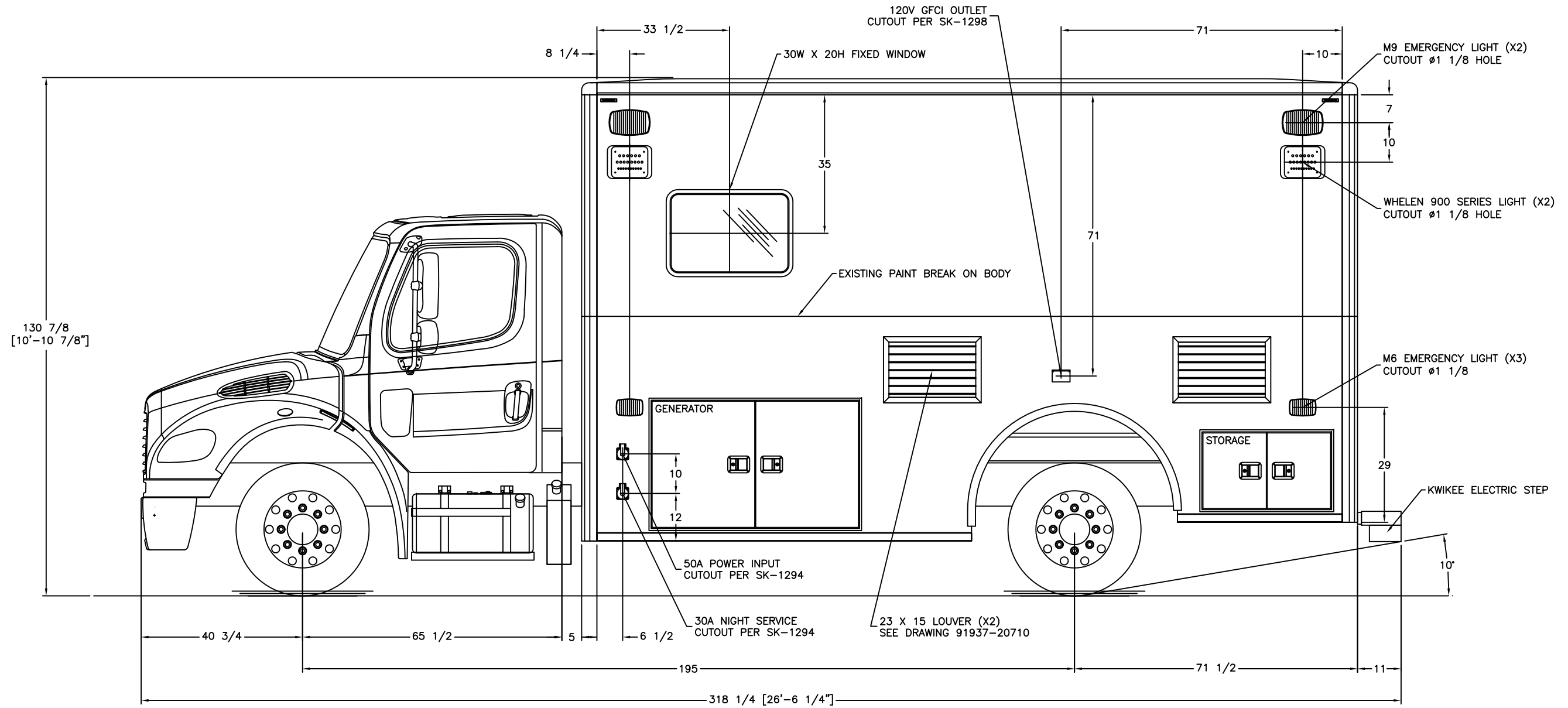

THIS DRAWING IS THE PROPERTY OF PIERCE MANUFACTURING CORPORATION. IT IS CONFIDENTIAL AND ALL RIGHTS ARE RESERVED. IT SHALL NOT BE REPRODUCED, COPIED, LENT, NOR USED FOR ANY PURPOSE OTHER THAN THAT FOR WHICH IT IS SPECIFICALLY FURNISHED.

DO NOT SCALE THIS DRAWING DIMENSIONS ARE IN INCHES UNLESS OTHERWISE SPECIFIED		MATERIAL SEE NOTES		12770 44th Street North Clearwater, FL 33762-4713 (727) 573-0400 FAX (727) 571-3295	
TOLERANCES: ANGULAR: ± 1° BEND: ± 1° 2 PLACE DECIMAL ± .010 3 PLACE DECIMAL ± .005 FRACTIONS ± 1/16		FINISH MILL FINISH		EXTERIOR LAYOUT STREET SIDE	
JOB NUMBER OR PRODUCT LINE 91937		DRAWN BY MRS	DATE 9/15/20		
SHEET 1 OF 1	SCALE 30	CHECKED BY JAB	DATE 09/17/20	SIZE B	DWG NO. 91937-50300

REVISIONS						
CHK DATE	CHK BY	DESCRIPTION		DATE	BY	REV
11/18/20	MRS	ENGINEERING RELEASE		11/05/20	PJS	00

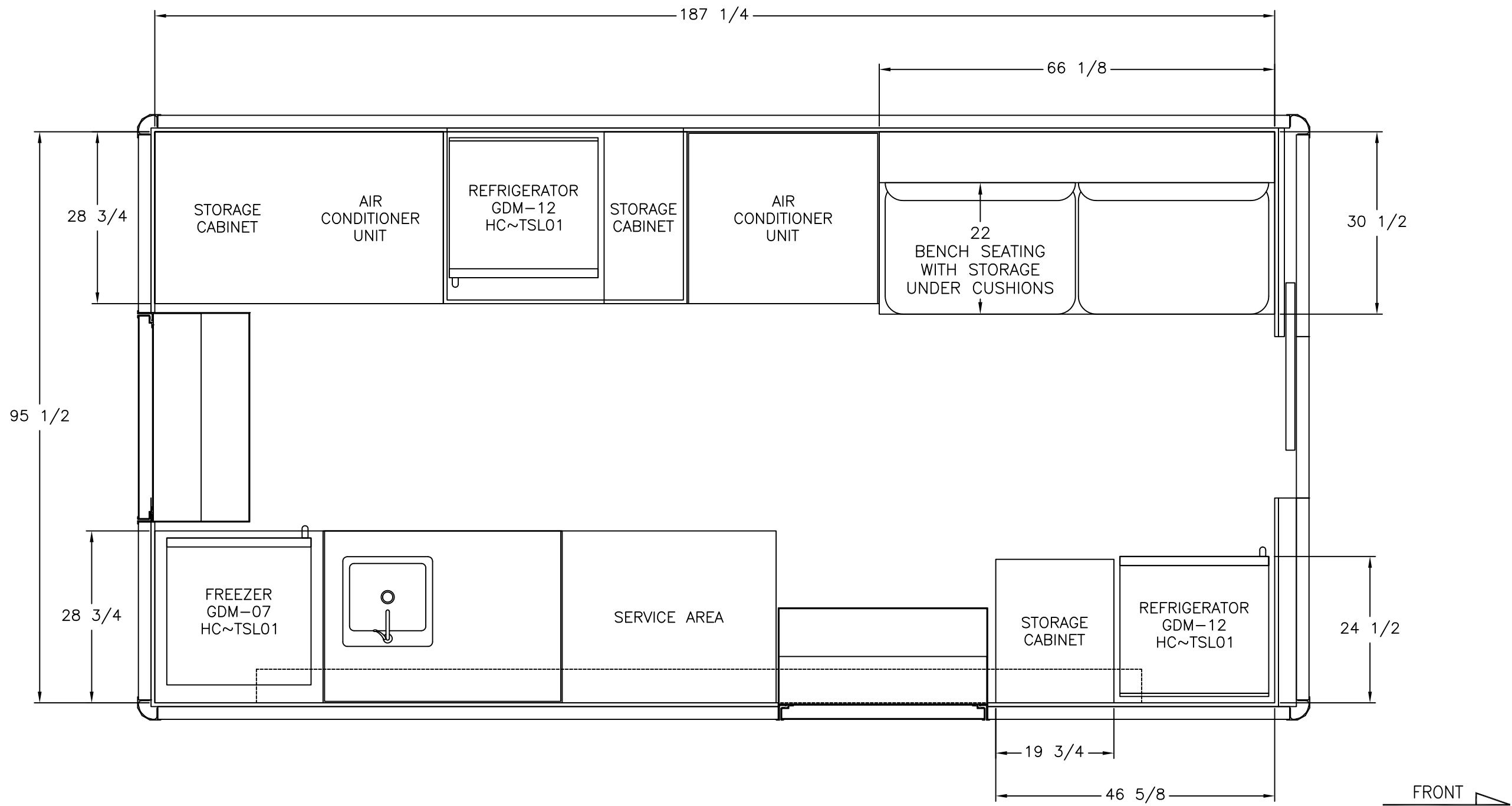

THIS DRAWING IS THE PROPERTY OF PIERCE MANUFACTURING CORPORATION. IT IS CONFIDENTIAL AND ALL RIGHTS ARE RESERVED. IT SHALL NOT BE REPRODUCED, COPIED, LENT, NOR USED FOR ANY PURPOSE OTHER THAN THAT FOR WHICH IT IS SPECIFICALLY FURNISHED.

DO NOT SCALE THIS DRAWING DIMENSIONS ARE IN INCHES UNLESS OTHERWISE SPECIFIED		MATERIAL SEE NOTES		12770 44th Street North Clearwater, FL 33762-4713 (727) 573-0400 FAX (727) 571-3295	
TOLERANCES: ANGULAR: ± 1° BEND: ± 1° 2 PLACE DECIMAL ± .010 3 PLACE DECIMAL ± .005 FRACTIONS ± 1/16		FINISH MILL FINISH		INTERIOR LAYOUT FLOOR	
JOB NUMBER OR PRODUCT LINE 91937		DRAWN BY PJS	DATE 11/05/20		
SHEET 1 OF 1	SCALE 20	CHECKED BY MRS	DATE 11/18/20	SIZE B	DWG NO. 91937-40100

REVISIONS						
CHK DATE	CHK BY	DESCRIPTION		DATE	BY	REV
11/18/20	MRS	ENGINEERING RELEASE		11/05/20	PJS	00

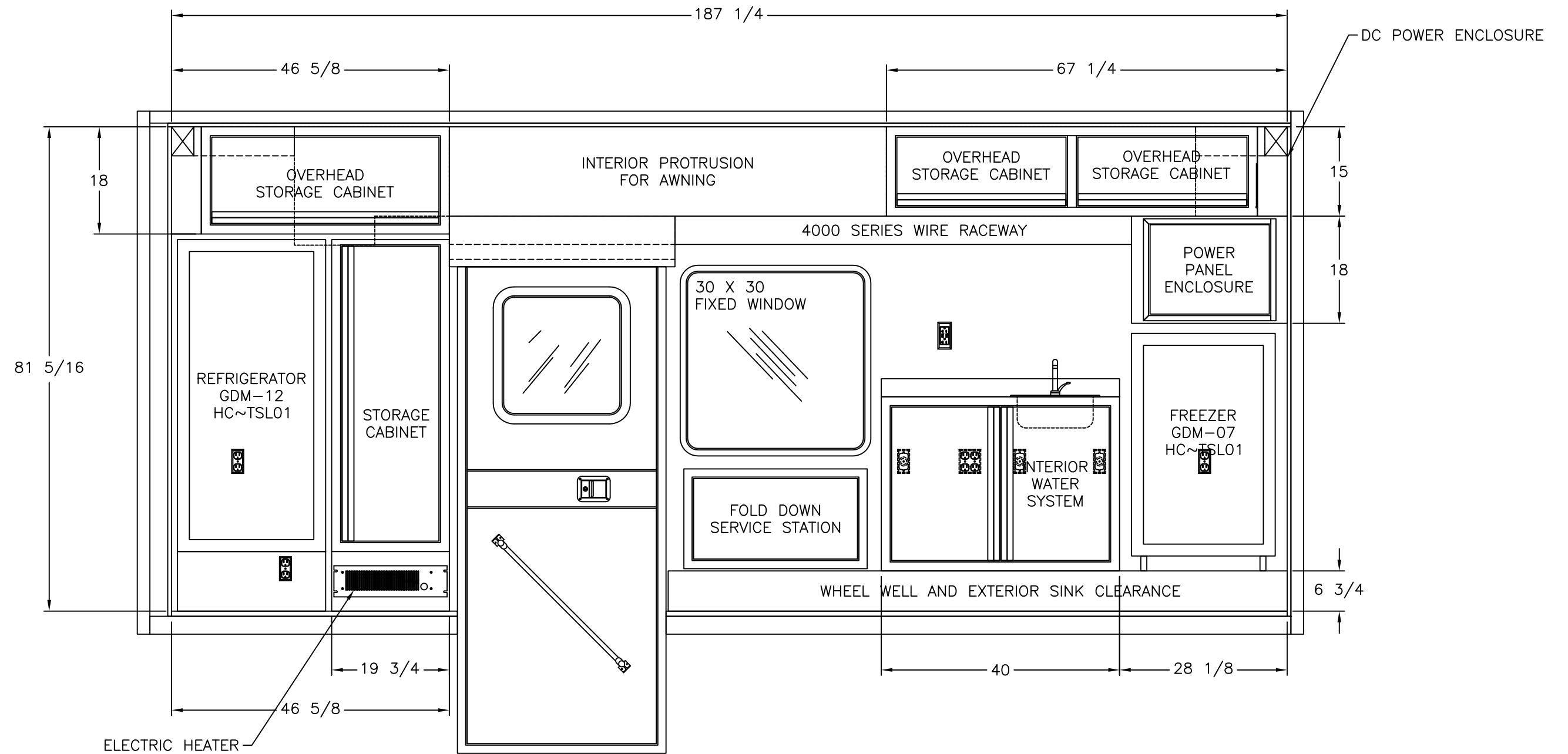

CURB SIDE INTERIOR

- 120V AC POWER / USB POWER
- 120V AC POWER (DUPLEX)
- 12V DC POWER (SPOTLIGHT)
- DIMMER SWITCH
- HVAC THERMOSTAT



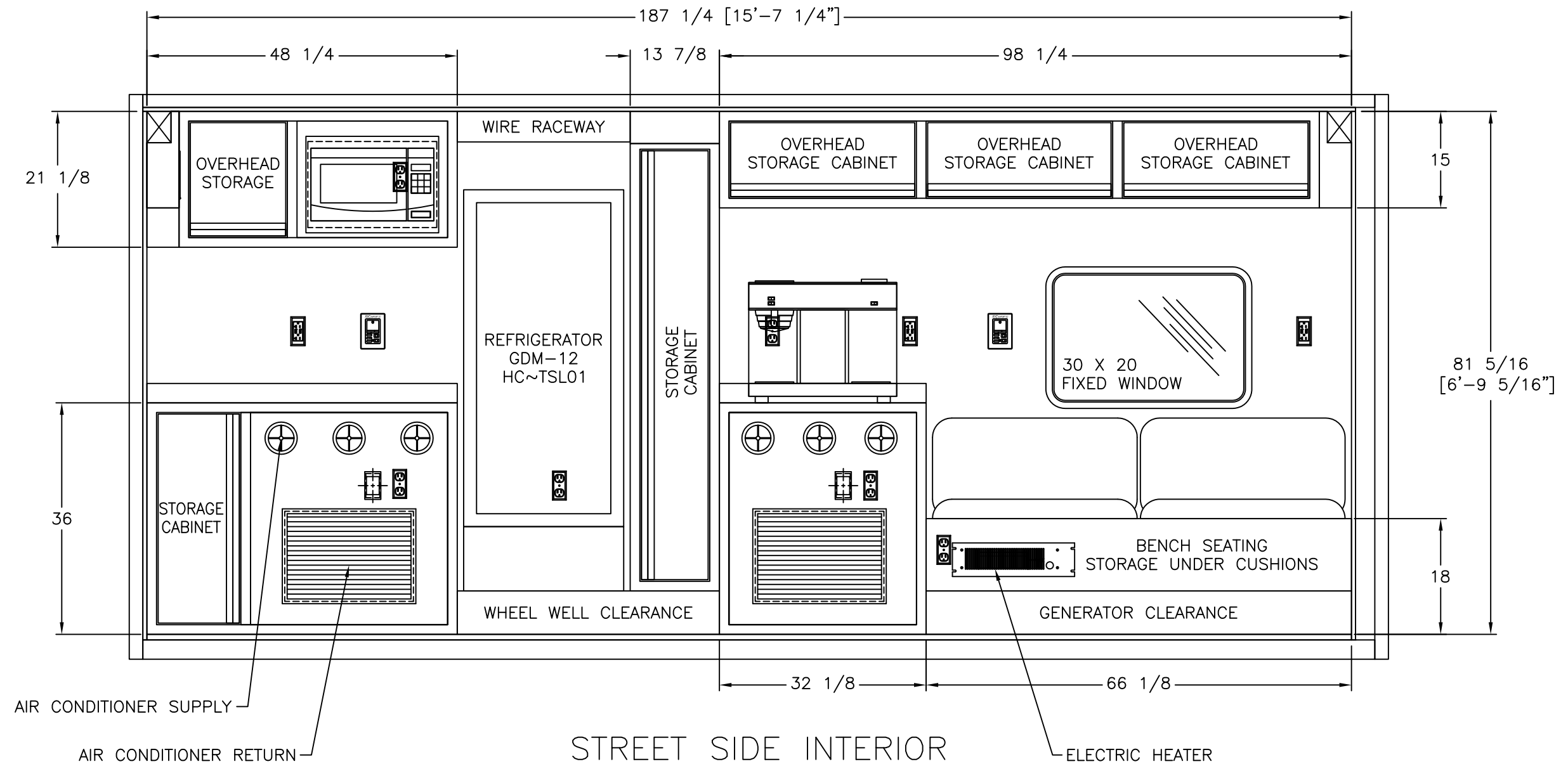

THIS DRAWING IS THE PROPERTY OF PIERCE MANUFACTURING CORPORATION. IT IS CONFIDENTIAL AND ALL RIGHTS ARE RESERVED. IT SHALL NOT BE REPRODUCED, COPIED, LENT, NOR USED FOR ANY PURPOSE OTHER THAN THAT FOR WHICH IT IS SPECIFICALLY FURNISHED.

DO NOT SCALE THIS DRAWING		MATERIAL		 12770 44th Street North Clearwater, FL 33762-4713 (727) 573-0400 FAX (727) 571-3295	
DIMENSIONS ARE IN INCHES UNLESS OTHERWISE SPECIFIED		SEE NOTES			
TOLERANCES:		FINISH		INTERIOR LAYOUT CURB SIDE	
ANGULAR: ± 1° BEND: ± 1"		MILL FINISH			
2 PLACE DECIMAL ± .010		DRAWN BY		DATE	
3 PLACE DECIMAL ± .005		PJS		11/05/20	
FRACTIONS ± 1/16		CHECKED BY		DATE	
JOB NUMBER OR PRODUCT LINE		MRS		11/18/20	
91937		SHEET		SIZE	
1 OF 1		SCALE		DWG NO.	
20		B		91937-40200	

REVISIONS						
CHK DATE	CHK BY	DESCRIPTION		DATE	BY	REV
11/18/20	MRS	ENGINEERING RELEASE		11/05/20	PJS	00



STREET SIDE INTERIOR

-  - 120V AC POWER / USB POWER
-  - 120V AC POWER (DUPLEX)
-  - LOW VOLTAGE DEVICE RING (SYSTEM)
-  - THERMOSTAT
-  - CO DETECTOR

THIS DRAWING IS THE PROPERTY OF PIERCE MANUFACTURING CORPORATION. IT IS CONFIDENTIAL AND ALL RIGHTS ARE RESERVED. IT SHALL NOT BE REPRODUCED, COPIED, LENT, NOR USED FOR ANY PURPOSE OTHER THAN THAT FOR WHICH IT IS SPECIFICALLY FURNISHED.

DO NOT SCALE THIS DRAWING DIMENSIONS ARE IN INCHES UNLESS OTHERWISE SPECIFIED		MATERIAL SEE NOTES		 12770 44th Street North Clearwater, FL 33762-4713 (727) 573-0400 FAX (727) 571-3295	
TOLERANCES: ANGULAR: ± 1° BEND: ± 1° 2 PLACE DECIMAL ± .010 3 PLACE DECIMAL ± .005 FRACTIONS ± 1/16		FINISH MILL FINISH		INTERIOR LAYOUT STREET SIDE	
JOB NUMBER OR PRODUCT LINE 91937		DRAWN BY PJS	DATE 11/05/20	SIZE B	DWG NO. 91937-40300
SHEET 1 OF 1	SCALE 20	CHECKED BY MRS	DATE 11/18/20		

REVISIONS

CHK DATE	CHK BY	DESCRIPTION	DATE	BY	REV
1/12/22	CJM	CHG WALK THRU TO PASS THRU - CO#1	1/12/22	MRS	01

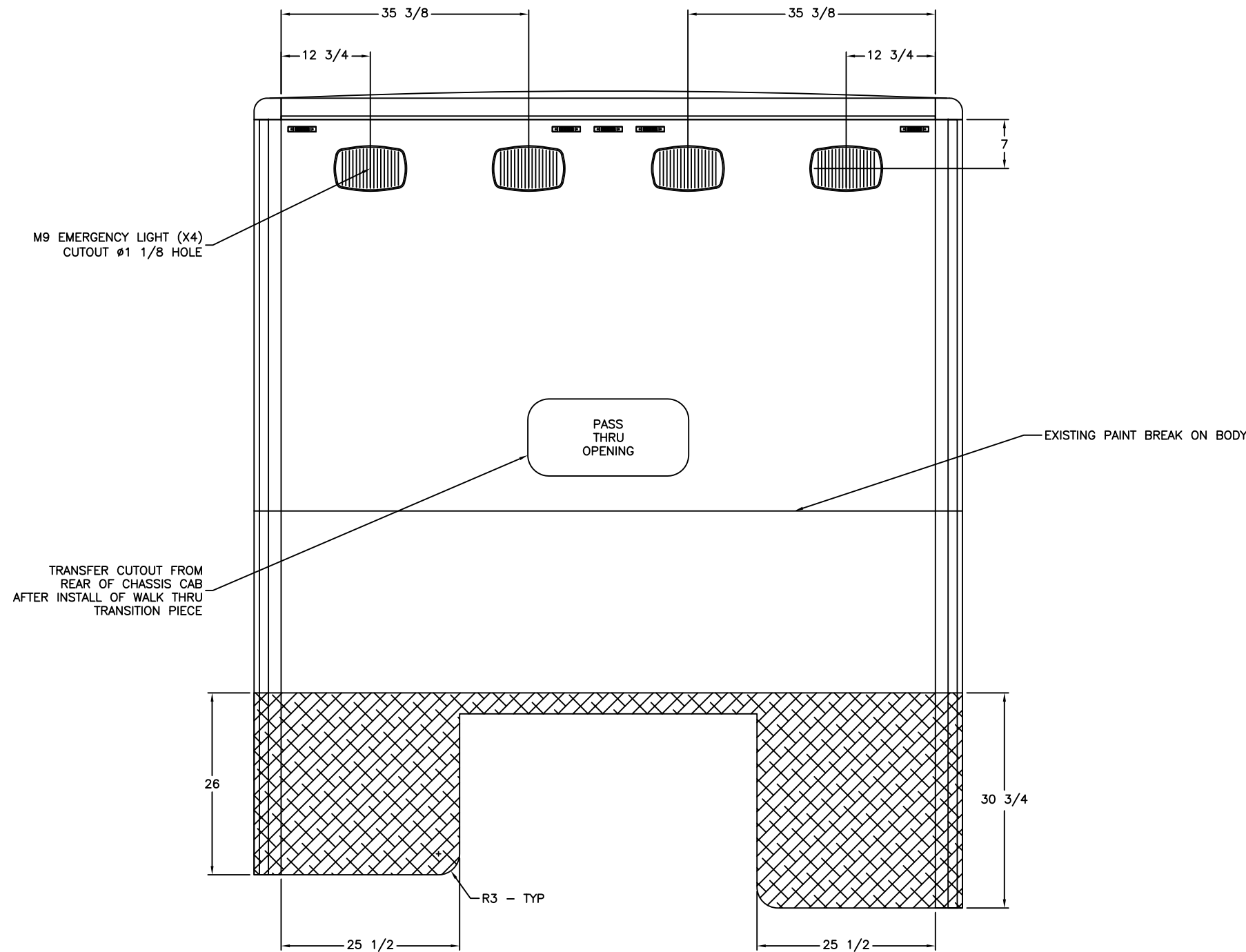

THIS DRAWING IS THE PROPERTY OF PIERCE MANUFACTURING CORPORATION. IT IS CONFIDENTIAL AND ALL RIGHTS ARE RESERVED. IT SHALL NOT BE REPRODUCED, COPIED, LENT, NOR USED FOR ANY PURPOSE OTHER THAN THAT FOR WHICH IT IS SPECIFICALLY FURNISHED.

DO NOT SCALE THIS DRAWING DIMENSIONS ARE IN INCHES UNLESS OTHERWISE SPECIFIED		MATERIAL SEE NOTES		 12770 44th Street North Clearwater, FL 33762-4713 (727) 573-0400 FAX (727) 571-3295	
TOLERANCES: ANGULAR: ± 1° BEND: ± 1° 2 PLACE DECIMAL ± .010 3 PLACE DECIMAL ± .005 FRACTIONS ± 1/16		FINISH MILL FINISH		EXTERIOR LAYOUT FRONT WALL	
JOB NUMBER OR PRODUCT LINE 91937		DRAWN BY MRS	DATE 9/15/20	SIZE B	
SHEET 1 OF 1	SCALE 20	CHECKED BY JAB	DATE 09/17/20	DWG NO. 91937-50400	

REVISIONS

CHK DATE	CHK BY	DESCRIPTION	DATE	BY	REV
10/11/21	MRS	ADDED TRIMARK TOUCH PAD AND LICENSE PLATE	03/29/22	PJS	02

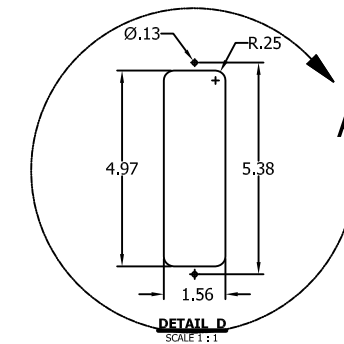
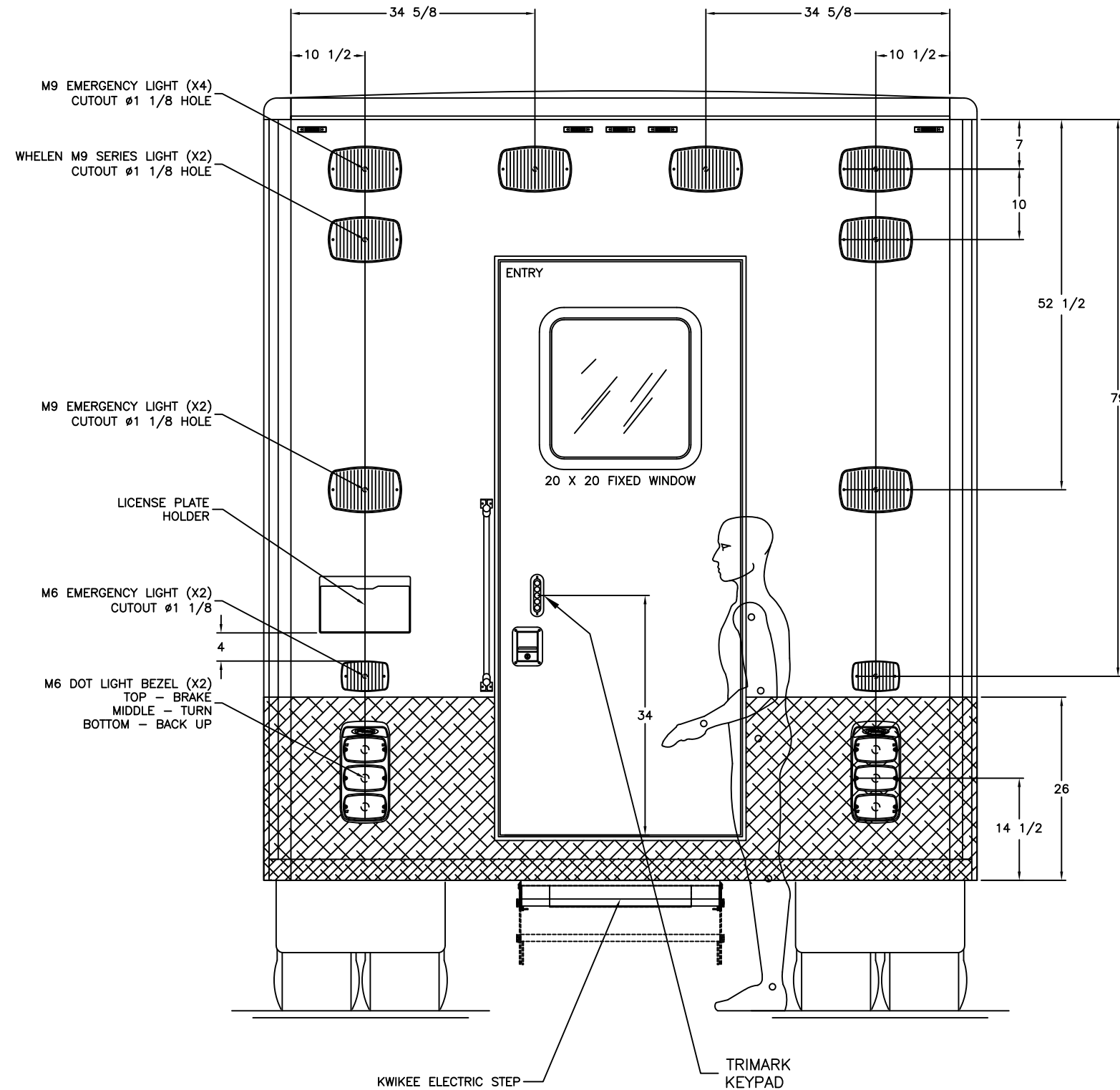

THIS DRAWING IS THE PROPERTY OF PIERCE MANUFACTURING CORPORATION. IT IS CONFIDENTIAL AND ALL RIGHTS ARE RESERVED. IT SHALL NOT BE REPRODUCED, COPIED, LENT, NOR USED FOR ANY PURPOSE OTHER THAN THAT FOR WHICH IT IS SPECIFICALLY FURNISHED.

DO NOT SCALE THIS DRAWING DIMENSIONS ARE IN INCHES UNLESS OTHERWISE SPECIFIED		MATERIAL SEE NOTES		 <p>12770 44th Street North Clearwater, FL 33762-4713 (727) 573-0400 FAX (727) 571-3295</p>	
TOLERANCES: ANGULAR: ± 1° BEND: ± 1" 2 PLACE DECIMAL ± .010 3 PLACE DECIMAL ± .005 FRACTIONS ± 1/16		FINISH MILL FINISH			
JOB NUMBER OR PRODUCT LINE 91937		DRAWN BY MRS	DATE 9/15/20	EXTERIOR LAYOUT REAR WALL	
SHEET 1 OF 1	SCALE 20	CHECKED BY JAB	DATE 09/17/20		